





MALTA DYNAMICS

**Full Body Harness  
Instruction Manual**



# Full Body Harness INSTRUCTION MANUAL

These instructions apply to the following model(s):

	
	
<b>B2000 Full Body Harness</b>	<b>B2102 Full Body Harness</b> (Malta Dynamics Branded)
<b>B2001 Full Body Harness</b>	<b>B2103 Full Body Harness</b> (Malta Dynamics Branded)
<b>B2002 Full Body Harness</b>	<b>B2106 Full Body Harness</b>
<b>B2003 Full Body Harness</b>	
<b>B2100 Full Body Harness</b>	
<b>B2101 Full Body Harness</b>	
<b>B2102 Full Body Harness</b> (EZLifLine Branded)	
<b>B2103 Full Body Harness</b> (EZLifLine Branded)	
<b>B2105 Full Body Harness</b>	

Manual Revision Code:  
**MD-FBHUIM161216**

*Please visit [www.MaltaDynamics.com](http://www.MaltaDynamics.com) for the latest user instruction manual revision available for this product offering.*

# TABLE OF CONTENTS

<b>Under Penalty of Law</b>	4
<b>Materials &amp; Construction</b>	4
<b>Purpose</b>	5
<b>Instructions for Use</b>	6
<b>Limitations for Use</b>	7
<b>Connector Compatibility Limitations</b>	8
<b>Connecting Component Limitations</b>	10
<b>Performance</b>	10
<b>Anchorage Requirements</b>	11
<b>Fall Clearance Requirements</b>	12
<b>Donning the Full Body Harness</b>	14
<b>Parts of the Full Body Harness</b>	16
<b>Training</b>	16
<b>Inspection</b>	17
<b>Cleaning and Maintenance</b>	19
<b>Product Specific Applications</b>	19
Applicable Uses for the Full Body Harness	20
<b>Product Labels</b>	21
<b>Inspection Log</b>	26
<b>Warranty</b>	27



# UNDER PENALTY OF LAW

This manual must be read and understood in its entirety, and used as part of a fall protection training program, as required by OSHA or any state/local regulatory agencies.

This manual is intended to meet industry standards required by ANSI Z359.0-2007 Fall Protection Code. The user must read and fully understand the limitations and proper use of the equipment, and be properly trained by the employer prior to use.

**NOTE:** This *User Instruction Manual* is not to be removed except by the equipment user. Current *User Instruction Manuals* must always be available to the user. Read and understand these instructions before using equipment. *Do not discard these instructions.*

## **WARNING**

Misuse or failure to follow warnings, instructions, and limitations on the use of this equipment may result in serious personal injury or death. For further instructions about proper use, refer to supervisor or contact Malta Dynamics at 1-800-494-1840.

## MATERIALS AND CONSTRUCTION

### Webbing Materials

- High tenacity polyester; breaking strength >5000 lbs. tensile strength

### Connector Materials





- Galvanized Steel

# PURPOSE

Malta Dynamics Full Body Harnesses are Class 3 full body harnesses designed for an array of full-body applications. Such full body harnesses are the only form of body wear acceptable for fall arrest. Full body harnesses may also be used for positioning, travel restraint, and rescue.

Malta Dynamics Harnesses are designed and tested to comply with applicable OSHA and ANSI standards for fall protection equipment. When used as a component in a personal fall arrest system or personal restraint system, Malta Dynamics Full Body Harnesses comply with OSHA directives for fall protection wear. Full body harnesses serve to better distribute the forces of a fall to suitable areas of a body and keep the body upright should a fall occur.

## Illustration 1: Applications

	<p><b>Personal Fall Arrest:</b> The full body harness is used as a component of a personal fall arrest system. Personal fall arrest systems typically include a full body harness and a connecting subsystem (energy absorbing lanyard). Maximum arresting force must not exceed 900 lbs (4 kN), for fall arrest applications connect the fall arrest subsystem (example: lanyard, SRL, energy absorber, etc.) to the D-ring or attachment element on your back, between your shoulder blades.</p>		<p><b>Work Positioning:</b> The full body harness is used as a component of a work positioning system to support the user at a work position. Work positioning systems typically include a full body harness, positioning lanyard, and a back-up personal fall arrest system. For work positioning applications, connect the work positioning subsystem (example: lanyard, Y-lanyard, etc.) to the lower (hip level) side or belt mounted work positioning attachment anchorage elements (D-rings). Never use these connection points for fall arrest.</p>
	<p><b>Rescue:</b> The full body harness is used as a component of a rescue system. Rescue systems are configured depending on the type of rescue. For limited access (confined space) applications, harnesses equipped with D-rings on the shoulders may be used for entry and egress into confined spaces where worker profile is an issue.</p>		<p><b>Controlled Descent:</b> For controlled descent applications, full body harnesses equipped with a single sternal level D-ring, one or two frontal mounted D-rings, or a pair of connectors originating below the waist (such as a seat sling) may be used for connection to a descender or evacuation system.</p>
	<p><b>Restraint:</b> The full body harness is used as a component of a restraint system to prevent the user from reaching a fall hazard. Restraint systems typically include a full body harness and a lanyard or restraint line.</p>		



# INSTRUCTIONS FOR USE

## WARNING

Do not alter or intentionally misuse this equipment.

- Full Body Harnesses which meet Z359.1-2007 and Z359.3 are intended to be used with other components of a Personal Fall Arrest system that limit maximum arrest forces to 1800 pounds (8 kN) or less.
- Employees shall be trained in accordance with the requirements of OSHA 29 CFR 1910.66 in the safe use of the system and its components before using a PFAS.
- Inspect all PFAS equipment for wear, damage, and other deterioration prior to each use. Remove defective equipment from service immediately.
- Thoroughly evaluate and plan all elements of Fall Protection System(s) before using this equipment. Make sure that your Personal Fall Arrest System is appropriate for your needs and facility. Calculate fall clearance and swing fall clearance. The clearance required is dependent on the type of connecting subsystem, the anchorage location, and other factors. When calculating distance, be sure to consider:
  - Deceleration Distance & Free-Fall Distance
  - Movement of Harness Attachment (D-Ring)
  - Worker Height (how tall is the worker?)
  - Elevation of Anchorage Connector
  - Connecting Subsystems Length & D-Ring Connector Length
  - Length of Full Body Harness Stretch
- Swings fall occur when the anchorage point is not directly above the point where a fall occurs. The force of striking an object in a swing fall may cause injury or death. Minimize potential swing falls by working as closely to the anchorage point as possible. Swing falls significantly increase the amount of clearance required. **See Illustration 2, below:**

### Illustration 2: Examples of Swing Fall Hazards

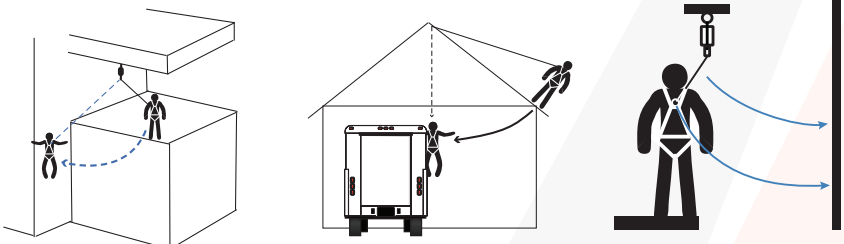

- Users must have a written rescue plan and the means to implement it. This plan must provide prompt employee rescue or ensure employees have the ability to rescue themselves in the event of a fall.
- Store this equipment in a cool, dry, and clean environment that is out of direct light when not in use to prevent UV degradation.
- This equipment must be removed from service IMMEDIATELY if a fall is incurred or if any part of the load indicator warning is showing.

## LIMITATIONS FOR USE

### WARNING

Do not use this equipment if you are unable to tolerate the impact of a fall arrest. Age and fitness can seriously affect your ability to withstand a fall. Consult with a physician if in doubt. Minors, pregnant women, and anyone with a history of back and/or neck problems must not use this equipment.

### WARNING

Use caution when employing this equipment around machines, electrical hazards, chemical hazards and sharp edges or abrasive surfaces, as contact may cause equipment failure, personal injury, or death.

- Use only with compatible components. Substitutions or replacements made with non-approved components or subsystems may jeopardize compatibility of equipment and may affect the safety and reliability of the complete system.
- Part numbers B2000, B2001, B2002, B2003, B2100, B2101, B2102, B2103, B2105, and B2106 are designed for a single user with combined weight—including clothing, tools, etc.—within a weight capacity range of 130 to 310 pounds.
- Use only with structures capable of supporting static loads required for Personal Fall Arrest Systems (PFAS). Anchorages used for PFAS must be capable of sustaining static loads in the direction permitted by the PFAS of at least: 3,600 pounds with certification of a qualified person, or 5,000 pounds without it. When more than one PFAS is attached to an anchorage, the strengths stated above must be met independently at and for each anchorage location.



- Do not expose this equipment to chemicals or harsh solutions that may have a harmful effect.
- User must not use or install equipment before receiving proper training from a competent person, as defined by OSHA 29 CFR 1926.32(f).
- Only Malta Dynamics shall make repairs or alterations to the equipment.
- All synthetic material must be protected from slag, hot sparks, open flames, or other heat sources. The use of heat-resistant materials is recommended in these applications.

## CONNECTOR COMPATIBILITY LIMITATIONS

Malta Dynamics' equipment must be coupled only to compatible connectors that are suitable to your application. Ensure all connections are compatible in size, shape, and strength. Ensure all connectors are fully closed and locked. OSHA 29 CFR 1926.502 prohibits the use of snap hooks to engage objects unless the following requirements are met:

- Snap hook must be a locking model.
- Snap hook must be explicitly designed for such a connection.

Use of a non-locking snap hook can result in rollout (a process by which a snap hook or carabiner unintentionally disengages from another connector or the object to which it is coupled (ANSI Z359.0- 2007). Malta Dynamics connectors (snap hooks and carabiners) are designed to be used only as specified in each product's user's instructions.

### Avoid the following types of connections:

- Two or more snap hooks or carabiners attached to one D-Ring.
- A snap hook connected to its integral lanyard.
- A snap hook connected to a horizontal lifeline.
- Connection in a manner that results in a load on the gate. NOTE: *Large throat opening snap hooks should not be connected to standard size D-Rings or similar objects, as such use will result in a load on the gate if the hook or D-Ring twists or rotates. Large throat snap hooks are designed for use on structural elements such as rebar or cross members that are not shaped in such a way that they may capture the gate of the hook.*
- False engagement connections, where protruding features of the snap hook or carabiner may catch on the anchor and seem fully engaged to the anchor point. Always confirm engagement.
- Connection to snap hooks or carabiners.
- Direct connection to webbing lanyard, webbing loop, rope lanyard or tie-back (unless the manufacturer's instructions for both the lanyard and connector specifically allow such a connection).





- Malta Dynamics' Full Body Harnesses shall be used as part of a personal fall arrest system that limits the maximum free-fall distance to six feet (1.8 m). If used with appropriate connecting systems, the Full Body Harnesses may be used with free falls exceeding six feet (1.8m)
- Full Body Harnesses shall only be used as part of a work positioning system that limits the maximum free-fall distance to two feet (0.6 m).
- Personal Energy Absorbers and Energy Absorbing Lanyards marked with, "ANSI Z359.13," and "Six-Foot Free Fall" are designed for up to six feet. Free-fall applications have a maximum capacity of 310 pounds. (141 kg) including clothing, tools, etc.
- Not all fall protection components are rated for the same user weight capacity. ONLY use components rated for the same weight capacity.
- This equipment is designed to be used in temperatures ranging from -40°F to +130°F (-40°C to +54°C).
- Connection of a snap hook to a D-Ring, rebar, or other connection point of improper dimensions in relation to the snap hook dimensions or configurations that could cause the snap hook keeper to be depressed by a turning motion of the snap hook, or such that snap hook or carabiner will not fully close and lock, or that roll-out could occur.
- **Illustration 3** depicts examples of inappropriate connections:

### Illustration 3: Inappropriate Connections



# CONNECTING COMPONENT LIMITATIONS

- A Competent Person must ensure the compatibility of all connections and of the system.
- Do not use the system if any connector does not lock or if any other component in the system does not operate properly.
- Allow sufficient safe clearance in the event of a free fall.
- System must be rigged to limit the total free-fall distance according to the type of system, and in compliance with ANSI and OSHA directives.
- Do not use if any part of the system appears to be damaged.
- Do not use a body belt for fall arrest applications.

## PERFORMANCE

Each Malta Dynamics' Full Body Harness has a minimum tensile breaking strength of 5,000 pounds (22.2 kN) when statically tested in accordance with the requirements of the ANSI Z359.1-2007 standard. Malta Dynamics' Full Body Harnesses stretch is less than eight inches.

Model/ Part #	Description (Materials & Size)	Capacity (Lbs.)	Size	Standard
B2000	Full Body Harness with Pass-Thru Leg Buckles	130-310	S, M, L	ANSI Z359.1-2007
B2001	Full Body Harness with Pass-Thru Leg Buckles	130-310	XL, XXL	ANSI Z359.1-2007
B2002	Full Body Harness with Tongue Buckle Legs	130-310	S, M, L	ANSI Z359.1-2007
B2003	Full Body Harness with Tongue Buckle Legs	130-310	XL, XXL	ANSI Z359.1-2007
B2100	Construction Full Body Harness with Tongue Buckle Legs and Belt	130-310	S, M, L	ANSI Z359.1-2007
B2101	Construction Full Body Harness with Tongue Buckle Legs and Belt	130-310	XL, XXL	ANSI Z359.1-2007
B2102	Construction Full Body Harness with Tongue Buckle Legs, Side D-Rings, and Belt	130-310	S, M, L	ANSI Z359.1- & Z359.3-2007
B2103	Construction Full Body Harness with Tongue Buckle Legs, Side D-Rings, and Belt	130-310	XL, XXL	ANSI Z359.1- & Z359.3-2007
B2105	Construction Full Body Harness with Tongue Buckle Legs and Belt	130-310	3XL	ANSI Z359.1-2007
B2106	Construction Full Body Harness with Tongue Buckle Legs, Side D-Rings, and Belt	130-310	3XL	ANSI Z359.1- & Z359.3-2007

## Applicable Standards:

Refer to national standards, including ANSI Z359.1, and local, state, and federal requirements (OSHA 1910.66, appendix C, 1926.500) for more information on Personal Fall Arrest Systems and associated components.

## Extended Suspension:

A Full Body Harness is intended as a Personal Fall Arrest System, meaning the user should be rescued immediately following a fall. A Full Body Harness is not intended for use in extended suspension applications. If the intended application requires the user to be suspended for an extended length of time, some form of seated support is recommended (for example: seat board, suspended work seat, seat sling or boatswain's chain).

# ANCHORAGE REQUIREMENTS

In accordance with ANSI Z359.1, anchorage selected for Personal Fall Arrest Systems must meet all anchorage strength requirements. Anchorage and anchorage strength requirements are dependent on the full body harness application **Note: see table on page 12.**

All anchorages for Personal Energy Absorbers and Absorbing Lanyards shall meet OSHA 29 CFR 1910.66 and ANSI Z359.1-2007 requirements. OSHA states: *Anchorages to which personal fall arrest equipment is attached shall be capable of supporting at least 5,000 pounds (22.2 kN) per employee attached, or shall be designed, installed, and used as part of a complete personal fall arrest system which maintains a safety factor of at least two, under the supervision of a qualified person.*

ANSI Z359.1-2007 states: *Anchorages in a personal fall arrest system must have strength capable of sustaining static loads applied in all directions permitted by the system of at least a.) two times the maximum arrest force permitted on the system with certification or, b.) 5,000 pounds (22.2 kN) without it.* When more than one personal fall arrest system is attached to an anchorage, the strength in (a) and (b) must be multiplied by the number of personal fall arrest systems attached.

Per ANSI Z359.4-2007: *Anchorages used in rescue systems and controlled descent must be capable of supporting loads of 3,100 ft-lb. (13.8 kN) for non-certified anchorages, or a 5:1 safety factor for certified anchorages.* Per ANSI Z359.2-2007: *Anchorages used in restraint systems must be capable of supporting loads of 1,000 ft-lb. (4.5 kN) for non-certified anchorages or two times the foreseeable force for certified anchorages.* Per ANSI Z359.2-2007: *Anchorages used in work positioning systems must be capable of supporting loads of 3,000 ft-lb. (13.3 kN) for non-certified anchorages or two times the foreseeable force for certified anchorages.*



Anchorage shall be located above the user's head in a vertical position, or they should be positioned as to not exceed the maximum allowable free-fall for the system.

Fall Arrest	Non-Certified Anchorage	5,000 lbs. (22.2kN)	Multiple Systems: When more than one of the defined systems is attached to an anchorage, the strength defined shall be multiplied by the number of systems attached to the anchorage.  Certified Anchorage: An anchorage for Personal Fall Arrest, Work Positioning, Restraint or Rescue systems that a qualified person certified to be capable of supporting the potential fall or that meets the criteria for a certified anchorage point, as prescribed by relevant ANSI and OSHA standards.
	Certified Anchorage	2X maximum arrest force	
Fall Restraint	Non-Certified Anchorage	1,000 ft-lb. (4.5 kN)	
	Certified Anchorage	2X the foreseeable force	
Work Positioning	Non-Certified Anchorage	3,000 ft-lb. (13.3 kN)	
	Certified Anchorage	2X the foreseeable force	
Rescue	Non-Certified Anchorage	3,100 ft-lb. (13.8 kN)	
	Certified Anchorage	5:1 safety factor	

## FALL CLEARANCE REQUIREMENTS

### Free Fall:

Maximum free fall distance allowed for use in a PFAS is six feet. For use in a Restraint or Rescue System, no free fall is permitted. For use in a Work Positioning System, maximum free-fall distance allowed is two feet. Do not work above the anchorage level to avoid increased Free Fall Distance.

### Fall Arrest Forces:

Full Body Harnesses which meet Z359.1-2007 and Z359.3 are intended to be used with other components of a Personal Fall Arrest System that limit maximum arrest forces to 1800 pounds (8 kN) or less. Deceleration distance should not be allowed to exceed 48 inches.

### Swing Falls:

Minimize swing fall by working as directly below the anchorage point as possible. Do not permit a swing fall if injury could occur.

## Fall Clearance:

Consider the following when calculating fall clearance. Required clearance is dependent on the following factors:

- Elevation of Anchorage
- Connecting Subsystem Length
- Deceleration Distance
- Free-Fall Distance
- Worker Height
- D-Ring / Connector Length
- Movement of Harness Attachment Element
- Length of Full Body Harness (FBH) Stretch
- Working Level

## Illustration 4: Minimize Swing Fall



Always attach to an overhead anchor. Swing falls significantly increase fall arrest distance.

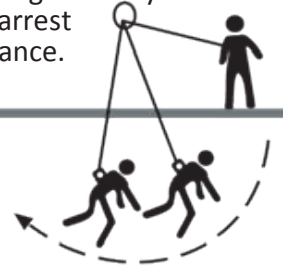

## Illustration 5: Fall Clearance Considerations

A. Connecting Subsystems (Energy Absorbing Lanyard shown) Length + Movement of Harness Attachment + Length of FBH Stretch

B. Working Level (Thickness)

C. Worker Height + Connector Length

D. Free-Fall—Six Foot Max. (per ANSI Z359.1)

E. Deceleration Distance

F. Total Fall Distance: Sum of A through E

G. Lower Level or Obstruction

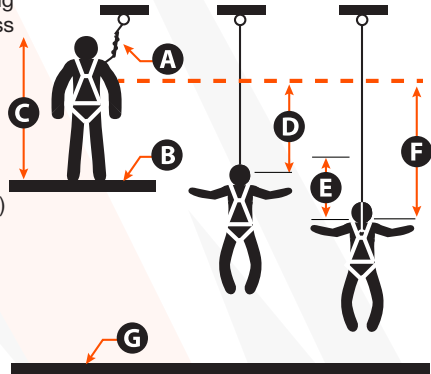

If there is a risk of a fall or if the only anchorage point is below the attachment points on the harness, it is essential to use a lanyard provided with an energy absorber. Before using a shock absorbing lanyard, ensure that there is sufficient fall clearance below the user to prevent any collision with the structure or ground.



### Calculating Total Fall Distances:

Total Fall Clearance below worker is calculated from Anchorage Connection. Free-Fall Distance + Working Level + Energy Absorber + Deceleration Distance + Worker Height + Connector Length + Safety Factor. Ensure that the total fall distance is clear of obstructions and equipment. Avoid potential contact with a lower level. **See Illustration 6.**

## DONNING THE FULL BODY HARNESS

Full Body Harnesses are the only approved form of body wear used for Fall Protection/Fall Arrest. Periodically adjust your harness to ensure proper fit at all times while in use. Do not allow harness to become loose or slack. The following steps describe how to properly put on a harness. To remove harness, reverse this procedure. **See Illustration 7.**

### Illustration 6: Calculating Total Fall Distance

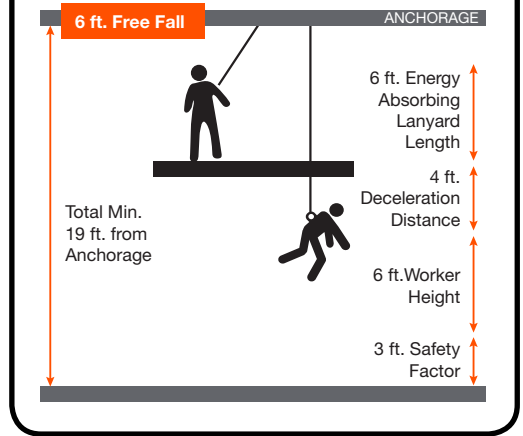

### Illustration 7: How to Put on Full Body Harness

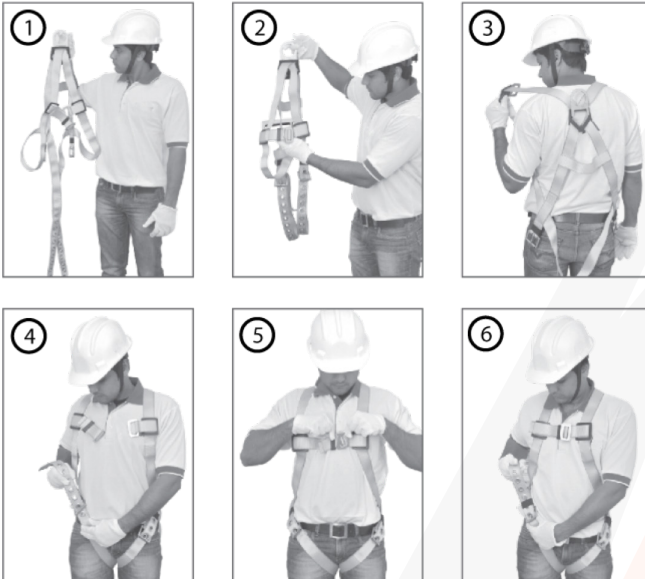

**Step 1:** Hold harness by grasping back D-ring. Shake harness to allow all straps to fall into place.

**Step 2:** If chest, waist and/or leg straps are fastened, release straps and unfasten at this time.

**Step 3:** Slip straps over shoulders so D-ring is located in the middle of your back, between shoulder blades.

**Step 4:** Pull leg strap between legs and fasten strap to connector. Repeat with second leg strap. Connect waist strap, if present. Waist strap should be snug, but not binding.

**Step 5:** Connect chest strap and position in mid-chest area (approximately 6” to 8” below the trachea, but not below the sternum). Pull shoulder straps snugly against your body.

**Step 6:** After all straps have been fastened, tighten or adjust all webbing so that harness fits snugly but allows full range of movement. Pass excess strap through strap keepers.

### Checking for Proper Harness Fit:

Proper connection of both types of straps is essential to fall safety. Failure to properly fit and adjust your harness may result in serious injury or death. **See Illustration 8.**

### Illustration 8: Proper Fit

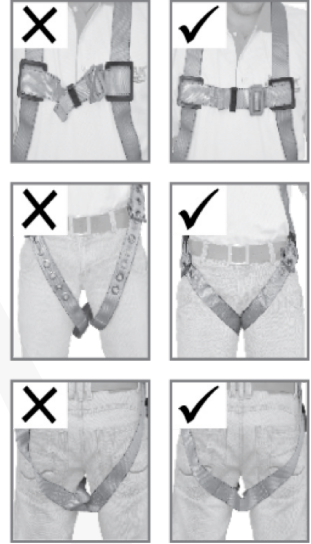

- **Chest Strap:** Should be positioned in the middle of your chest [6” (152mm) to 8” (203mm) below the trachea but not below the sternum]. If the chest strap is positioned too high, the strap may move upwards during a fall arrest causing you to run the risk of strangulation. If the chest strap is too low or not connected at all, you could fall out of your harness during a fall.
- **Leg Straps:** Proper adjustment of the leg straps is critical for safety. Leg straps should be snug, but not snug to the point that they obstruct normal blood circulation in the legs. Failure to wear leg straps will not secure your body within the harness during a fall and could lead to serious injury or death.
- **Sub-pelvic Strap:** Provides support in the event of a fall, and also provides support when used for positioning. In a seated position, the sub pelvic strap should comfortably provide a “seat” for the buttocks. In the event of a fall, simply lift up your legs to transfer weight to the sub-pelvic strap.



# PARTS OF THE FULL BODY HARNESS

All Malta Dynamics' Harness Models (Illustration 9a):

- 1.) Shoulder Straps
- 2.) Chest Strap
- 3.) Torso Adjustment
- 4.) Tongue Buckle/  
Quick-Connect Fastener
- 5.) Thigh Strap
- 6.) Dorsal D-Ring
- 7.) Back Plate
- 8.) Sub-Pelvic Strap
- 9.) Inspection/ ID Label
- 10.) Warning/ Instruction Label
- 11.) Standards Label
- 12.) Lanyard Parking  
Attachment
- 13.) Lanyard Parking Label
- 14.) Strap Retainer
- 15.) Load Indicator

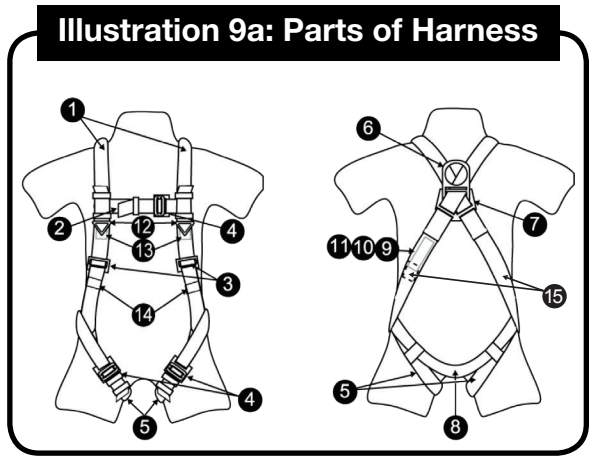

**NOTE:** Some harness models feature belts and/or the following parts (Illustration 9b):

- 1.) Shoulder Padding
- 2.) Waist Belt
- 3.) Hip D-Ring/Positioning D-Ring  
(used in pairs only)

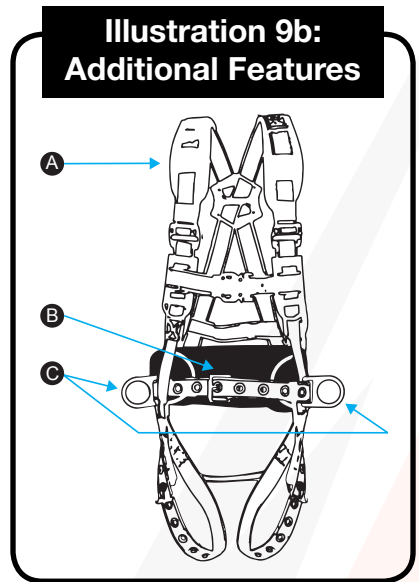

## TRAINING

Employers are responsible for providing training to any employee who may be exposed to fall hazards in order to enable the employee to recognize and reduce fall hazards. Training must be conducted by a Competent or Qualified Person. Trainer and trainees must not be exposed to fall hazards during the training course.



# INSPECTION

## Competent Person Inspection:

Harness must be inspected by a competent person at a minimum of twice per year (every six months). If the harness is exposed to extreme or severe conditions, more frequent formal inspections may be required. Record the results of each formal inspection in your Hog Tracker account or inspection log. Remove harness from service immediately after a fall has occurred.

## User Inspection:

Full body harness should be inspected by the user before each use with the following inspection (**Illustration 9, on page 17**). In addition, the unit should be fully examined to ensure:

- Markings are legible.
- All connectors and buckles engage securely.
- Metal parts are free from corrosion, bending, cracks, dents, or deformity.
- Webbing shows no evidence of rips, tears, frayed edges, broken fibers, pulled stitches, cuts, burns, and chemical damage.
- Harness is clean and free of dirt, old, mold, mildew, and other contaminants.
- Load indicator warning must be checked. If any part of the fall indicator warning (located on the webbing below the dorsal D-Ring pass) is showing, the Malt Dynamics' Full Body Harness must be removed from service.

## Inspection Procedures:

### Step 1: Webbing/ Stitches

Grasp webbing in your hands approximately six inches (152mm) to eight inches (203mm) apart. Bend webbing in an inverted "U" as shown. The resulting surface tension will allow easier detection of damaged fibers or cuts. Follow this procedure along the entire length of the webbing, inspecting both sides of each strap. Watch for frayed edges, broken fibers, pulled stitches, cuts, burns, and chemical damage.

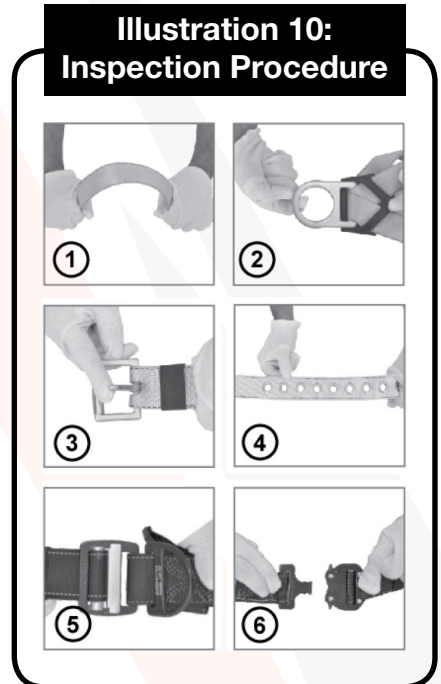

## Step 2: D-Rings/Pads

Check D-rings for distortion, cracks, breaks, and rough or sharp edges. D-ring should pivot freely. Inspect for any unusual wear, frayed or cut fibers, or broken stitching of the D-ring attachments. Pads should also be inspected for cracks, excessive wear, or other signs of damage.

## Step 3: Buckles

Inspect for any unusual wear, frayed or cut fibers, or broken stitching of the buckle attachments.

## Step 4: Tongue Buckles/ Grommets

Buckle tongues should be free of distortion in shape and motion. They must overlap the buckle frame and move freely back and forth in the socket. Roller should turn freely on frame. Check for distortion or sharp edges. Inspect for loose, distorted, or broken grommets. Webbing should not have additional punched holes.

## Step 5: Friction and Slotted Mating Buckles

Inspect buckle for distortion. Outer bars and center bars must be straight. Also look for any evidence of distortion or defective condition in corners and attachment points at the center bar.

## Step 6: Quick Connect Buckles

Inspect buckle for distortion. Outer bars and center bars must be straight. Dual-tab release mechanism must be free of debris and must engage properly.

**NOTE:** If inspection reveals any defect, inadequate maintenance, or unsafe condition, remove Full Body Harness from service immediately.

## Inspection Frequency:

**NOTE:** Any harness with noticeable damage or wear shall be removed from service immediately.

After a fall occurs or if any part of the load indicator warning is showing (**Illustration 11**), the Full Body Harness must be removed from service immediately. If inspection reveals any defect, poor maintenance, or wear and tear, remove it from service.

Any equipment that has been subjected to the forces of arresting a fall must be removed from service immediately.

**NOTE:** Only manufacturer, or entities authorized in writing by the manufacturer, may make repairs to the product. Otherwise, equipment must not be altered in any way.

## Illustration 11: Load Indicator



## CLEANING AND MAINTENANCE

### Cleaning

Wipe off all surface dirt. Store in clean, dry space, away from heat and areas where chemical vapors may exist. Avoid storing in direct light to prevent UV degradation.

### Maintenance

Do not attempt to disassemble or repair. Only Malta Dynamics or entities authorized in writing by Malta Dynamics shall make repairs, authorize maintenance, or make alterations to the equipment.

## PRODUCT SPECIFIC APPLICATIONS

The following section outlines product specific applications and proper equipment use for Malta Dynamics' Full Body Harnesses. Note: For all applications, worker weight capacity range is 130 to 310 pounds.

## WARNING

Use of equipment in unintended applications may result in serious injury or death. **NOTE:** Maximum one attachment per connection point, .



## Applicable Uses for the Full Body Harness:

The Malta Dynamics' Full Body Harness is designed to support one of three applicable uses:

### **Personal Fall Arrest:** (Applicable D-Ring type: Dorsal)

The full body harness can be used to support a maximum of one Personal Fall Arrest System (PFAS for fall arrest applications. The structure must be able to withstand loads applied in the directions permitted by the system of at least 5,000 pounds. Free-falling is not permitted.

### **Fall Restraint:** (Applicable D-Ring types: Dorsal, Chest, Side, Shoulder)

The full body harness can be used in restraint applications. Restraint systems prevent workers from reaching the leading edge of a fall hazard. The structure must be able to withstand loads applied in the directions permitted by the system of at least 1,000 pounds. Restraint systems may only be used on surfaces with slopes up to 4/12 (vertical/horizontal). Free-falling is not permitted.

### **Rescue/Retrieval:** (Applicable D-Ring types: Dorsal, Chest, Shoulder)

The full body harness can be used in rescue/confined space applications to safely recover a worker from a confined space or after having been exposed to a fall. The structure must be able to withstand loads applied in the directions permitted by the system of at least 3,000 pounds. Free-falling is not permitted.

# PRODUCT LABELS

The following labels are affixed to the product and must not be removed:



**1**



**5-Point Full Body Harness with Pass-Thru Buckles**

ANSI / OSHA 2389.L2007 A10.32(2012) S, M, L (Universal)

**EZ LIFELINE**  
WHEN SAFETY MATTERS

MATERIAL: Polyester, Nylon, Steel  
CAPACITY: 130-310 lbs (including weight of work)

MFG. DATE: \_\_\_\_\_  
SERIAL# \_\_\_\_\_ PART# \_\_\_\_\_  
BATCH# \_\_\_\_\_ **EZB2000**

**2**



**5-Point Full Body Harness with Pass-Thru Buckles**

ANSI / OSHA 2389.L2007 A10.32(2012) XL-XXL

**EZ LIFELINE**  
WHEN SAFETY MATTERS

MATERIAL: Polyester, Nylon, Steel  
CAPACITY: 130-310 lbs (including weight of work)

MFG. DATE: \_\_\_\_\_  
SERIAL# \_\_\_\_\_ PART# \_\_\_\_\_  
BATCH# \_\_\_\_\_ **EZB2001**

**3**



**5-Point Full Body Harness with Tongue Buckles**

ANSI / OSHA 2389.L2007 A10.32(2012) S, M, L (Universal)

**EZ LIFELINE**  
WHEN SAFETY MATTERS

MATERIAL: Polyester, Nylon, Steel  
CAPACITY: 130-310 lbs (including weight of work)

MFG. DATE: \_\_\_\_\_  
SERIAL# \_\_\_\_\_ PART# \_\_\_\_\_  
BATCH# \_\_\_\_\_ **EZB2002**

**4**



**5-Point Full Body Harness with Tongue Buckles**

ANSI / OSHA 2389.L2007 A10.32(2012) XL-XXL

**EZ LIFELINE**  
WHEN SAFETY MATTERS

MATERIAL: Polyester, Nylon, Steel  
CAPACITY: 130-310 lbs (including weight of work)

MFG. DATE: \_\_\_\_\_  
SERIAL# \_\_\_\_\_ PART# \_\_\_\_\_  
BATCH# \_\_\_\_\_ **EZB2003**

**B2000, B2001**



**B2002, B2003**



**NOTE:** These labels represent an **older graphic version** which may be present on your product. The standards met listed on the labels are correct though.

**5**

**WARNING:** Read all manufacturer's instructions before use. Remove equipment from service immediately if it has been subjected to a fall arrest event. Avoid sharp edges and abrasive surfaces. Inspect before each use. Use only compatible connections. Use dorsal D-Ring for fall arrest attachment. Side D-Rings are for positioning only. Use front mounted attachment for limited fall arrest having max. 2 ft. free fall distance. **DO NOT REMOVE THIS LABEL.**

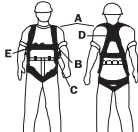

A = SHOULDER STRAP  
B = CHEST STRAP  
C = FRONT ADJUSTMENT STRAP  
D = BACK D-RING  
E = LANYARD KEEPER

**WARNING:** REMOVE FROM SERVICE if equipment has been subjected to a fall arrest event or if equipment fails inspection.

**USER MUST INSPECT EQUIPMENT BEFORE EACH USE.**

This equipment contains a 3.356 MHz SMART TAG

Scan RFID tag for product information, updates, online inspection logs & checklists & more!

W	V	M	A	M	O	N	D	A	T	E

Competent person must inspect and initial at least every 6 months.  
Record Date of First Use.  
Service Life of this Item is 5 years from Date of First Use.

**DO NOT REMOVE THIS LABEL.**  
Made in India

**6**

**FALL INDICATOR**

**WARNING**

**DO NOT REUSE any unit that has arrested a fall or has this fall indicator deployed. Remove from service immediately.**

**EZ LIFELINE**  
800-417-9272  
ezlifeline.com  
405 Watertown Road, Watertown OH 45788

**1**



**5-Point Full Body Harness with Pass-Thru Leg Buckles**

ANSI 2385.1-2007 S, M, L (Universal)  
A10.32-2012

MALTA DYNAMICS

**2**



**5-Point Full Body Harness with Pass-Thru Leg Buckles**

ANSI 2385.1-2007 XL-XXL  
A10.32-2012

MALTA DYNAMICS

**MATERIAL:** Polyester, Nylon, Steel  
**CAPACITY:** 3 Worker  
**WORKING LOAD RANGE:** 130-310 lbs

MFG. DATE: \_\_\_\_\_  
SERIAL# \_\_\_\_\_ PART# B2000  
BATCH# \_\_\_\_\_

**WARNING:** Follow all manufacturer's instructions included with this equipment at time of shipment. Improper use of equipment could result in serious injury or death. **DO NOT REMOVE THIS LABEL.**

**MATERIAL:** Polyester, Nylon, Steel  
**CAPACITY:** 3 Worker  
**WORKING LOAD RANGE:** 130-310 lbs

MFG. DATE: \_\_\_\_\_  
SERIAL# \_\_\_\_\_ PART# B2001  
BATCH# \_\_\_\_\_

**WARNING:** Follow all manufacturer's instructions included with this equipment at time of shipment. Improper use of equipment could result in serious injury or death. **DO NOT REMOVE THIS LABEL.**

**3**



**5-Point Full Body Harness with Tongue Buckle Legs**

ANSI 2385.1-2007 S, M, L (Universal)  
A10.32-2012

MALTA DYNAMICS

**4**



**5-Point Full Body Harness with Tongue Buckle Legs**

ANSI 2385.1-2007 XL-XXL  
A10.32-2012

MALTA DYNAMICS

**MATERIAL:** Polyester, Nylon, Steel  
**CAPACITY:** 3 Worker  
**WORKING LOAD RANGE:** 130-310 lbs

MFG. DATE: \_\_\_\_\_  
SERIAL# \_\_\_\_\_ PART# B2002  
BATCH# \_\_\_\_\_

**WARNING:** Follow all manufacturer's instructions included with this equipment at time of shipment. Improper use of equipment could result in serious injury or death. **DO NOT REMOVE THIS LABEL.**

**MATERIAL:** Polyester, Nylon, Steel  
**CAPACITY:** 3 Worker  
**WORKING LOAD RANGE:** 130-310 lbs

MFG. DATE: \_\_\_\_\_  
SERIAL# \_\_\_\_\_ PART# B2003  
BATCH# \_\_\_\_\_

**WARNING:** Follow all manufacturer's instructions included with this equipment at time of shipment. Improper use of equipment could result in serious injury or death. **DO NOT REMOVE THIS LABEL.**

**B2000, B2001**



**B2002, B2003**



**NOTE:** These labels represent the newer graphic version which may be present on your product. The standards met listed on the labels are correct.

**5**

**WARNING:** Read all manufacturer's instructions before use. Remove equipment from service immediately if it has been subjected to a fall arrest event. Avoid sharp edges and abrasive surfaces. Inspect before each use. Use only compatible connections. Use dorsal D-Ring for fall arrest attachment. Side D-Rings are for positioning only. Use front mounted attachment for limited fall arrest having max. 2 ft. free fall distance. **DO NOT REMOVE THIS LABEL.**

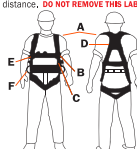

A = SHOULDER STRAP  
B = CHEST STRAP  
C = FRONT ADJUSTMENT STRAP  
D = BACK D-RING  
E = LANYARD KEEPER  
F = SIDE D-RING

**WARNING:** REMOVE FROM SERVICE if equipment has been subjected to a fall arrest event or if equipment fails inspection.

**USER MUST INSPECT EQUIPMENT BEFORE EACH USE.**

**HAG TAG** 13.56 MHz SMART TAG  
Scan RFID tag for product information, manuals & more!

1	2	3	4	5	6	7	8	9	10	11	12	13	14	15	16	17	18	19	20	

Compliant person must inspect and initial at least every 6 months.  
Record Date of First Use: \_\_\_\_\_  
Service Life of this Item is 5 years from Date of First Use.

**DO NOT REMOVE THIS LABEL.**  
Made in India

**6**

**FALL INDICATOR**

**WARNING**

**DO NOT REUSE any unit that has arrested a fall or has this fall indicator deployed. Remove from service immediately.**

MALTA DYNAMICS  
800-494-1840  
210 33rd Street | Malta, OH 43078





MATERIAL: Polyester, Nylon, Steel  
CAPACITY: 130-310 lbs. (includes tools)

MFG. DATE: \_\_\_\_\_  
SERIAL# \_\_\_\_\_ PART# \_\_\_\_\_  
BATCH# \_\_\_\_\_ EZB2100

**ⓘ** WARNING: Follow all manufacturer's instructions included with this equipment at time of shipment. Improper use of equipment could result in serious injury or death. **DO NOT REMOVE THIS LABEL.**



MATERIAL: Polyester, Nylon, Steel  
CAPACITY: 130-310 lbs. (includes tools)

MFG. DATE: \_\_\_\_\_  
SERIAL# \_\_\_\_\_ PART# \_\_\_\_\_  
BATCH# \_\_\_\_\_ EZB2102

**ⓘ** WARNING: Follow all manufacturer's instructions included with this equipment at time of shipment. Improper use of equipment could result in serious injury or death. **DO NOT REMOVE THIS LABEL.**



MATERIAL: Polyester, Nylon, Steel  
CAPACITY: 130-310 lbs. (includes tools)

MFG. DATE: \_\_\_\_\_  
SERIAL# \_\_\_\_\_ PART# \_\_\_\_\_  
BATCH# \_\_\_\_\_ EZB2101

**ⓘ** WARNING: Follow all manufacturer's instructions included with this equipment at time of shipment. Improper use of equipment could result in serious injury or death. **DO NOT REMOVE THIS LABEL.**



MATERIAL: Polyester, Nylon, Steel  
CAPACITY: 130-310 lbs. (includes tools)

MFG. DATE: \_\_\_\_\_  
SERIAL# \_\_\_\_\_ PART# \_\_\_\_\_  
BATCH# \_\_\_\_\_ EZB2103

**ⓘ** WARNING: Follow all manufacturer's instructions included with this equipment at time of shipment. Improper use of equipment could result in serious injury or death. **DO NOT REMOVE THIS LABEL.**

### B2100, B2101



### B2102, B2103



**NOTE:** These labels represent an older graphic version which may be present on your product. The standards met listed on the labels are correct though.

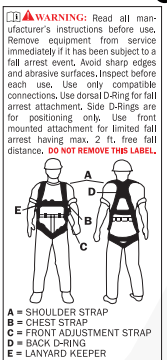

**⚠ WARNING:** REMOVE FROM SERVICE if equipment has been subject to a fall arrest event or if equipment fails inspection.

**USER MUST INSPECT EQUIPMENT BEFORE EACH USE.**

This equipment contains a 13.56 MHz SMART TAG



Scan RFID tag for product information, updates, online inspection logs & checklists & more!

W	T	M	T	F	S	S	A	O	D

Competent person must inspect and initial at least every 6 months.

Record Date of First Use:  
Service Life of This Item is 5 years from Date of First Use.

**DO NOT REMOVE THIS LABEL.**  
Made in India

**6**

**FALL INDICATOR**

**⚠ WARNING**

**DO NOT REUSE any unit that has arrested a fall or has this fall indicator deployed. Remove from service immediately.**

**EZLIFLINE**  
800-417-9272  
ezlifline.com  
405 Watertown Road, Watertown OH 45786







# WARRANTY

The following warranty is made in lieu of all warranties or conditions, whether expressed or implied. This includes the implied warranties or conditions of merchantability or fitness for a particular purpose.

Equipment offered by Malta Dynamics is warranted against factory defects in workmanship and materials for a period of one year from date of installation or first use by the original owner.

**LIMITED REMEDY:** Upon notice in writing, Malta Dynamics will repair or replace all defective items at Malta Dynamics's sole discretion. Malta Dynamics reserves the right to require that the defective item to be returned to its plant for inspection before determining the appropriate course of action.

This warranty does not cover equipment damage resulting from wear, abuse, damage in transit, failure to maintain the product or other damage beyond the control of Malta Dynamics. Malta Dynamics shall be the sole judge of product condition and warranty options. This warranty applies only to the original purchaser and is the only warranty applicable to this product. Please contact Malta Dynamics customer service department at 800-494-1840 for assistance.

**LIMITATION OF LIABILITY:** IN NO EVENT WILL MALTA DYNAMICS BE LIABLE FOR ANY INDIRECT, INCIDENTAL, SPECIAL OR CONSEQUENTIAL DAMAGES— INCLUDING, BUT NOT LIMITED TO—LOSS OF PROFITS IN ANY WAY RELATED TO THE PRODUCTS, REGARDLESS OF ANY LEGAL THEORY ASSERTED.





# MALTA DYNAMICS

800-494-1840  
MaltaDynamics.com  
210 13th Street  
Malta, OH 43758 USA